

** PPT cannot be distributed per customer requirements**

PAC-3[®] MSE Overview

Approved for Public Release – DAL2024070273



Outline

- PAC-3 Evolution
- Hit-to-Kill Technology
- Patriot and PAC-3 Missile Segment Enhancement (MSE)
- M903 Launcher Upgrades
- Summary and Reference Data



PAC-3 Evolution

PAC-3 missiles defend against incoming threats – including tactical ballistic missiles, cruise missiles and aircraft - through direct body-to-body contact delivering exponentially more kinetic energy on the target than can be achieved with blast-fragmentation kill mechanisms.

Building on the combat-proven PAC-3 Cost Reduction Initiative (CRI), the PAC-3 MSE expands the lethal battlespace with a two-pulse solid rocket motor, providing increased performance in altitude and range.



PAC-3 MSE Historical Timeline

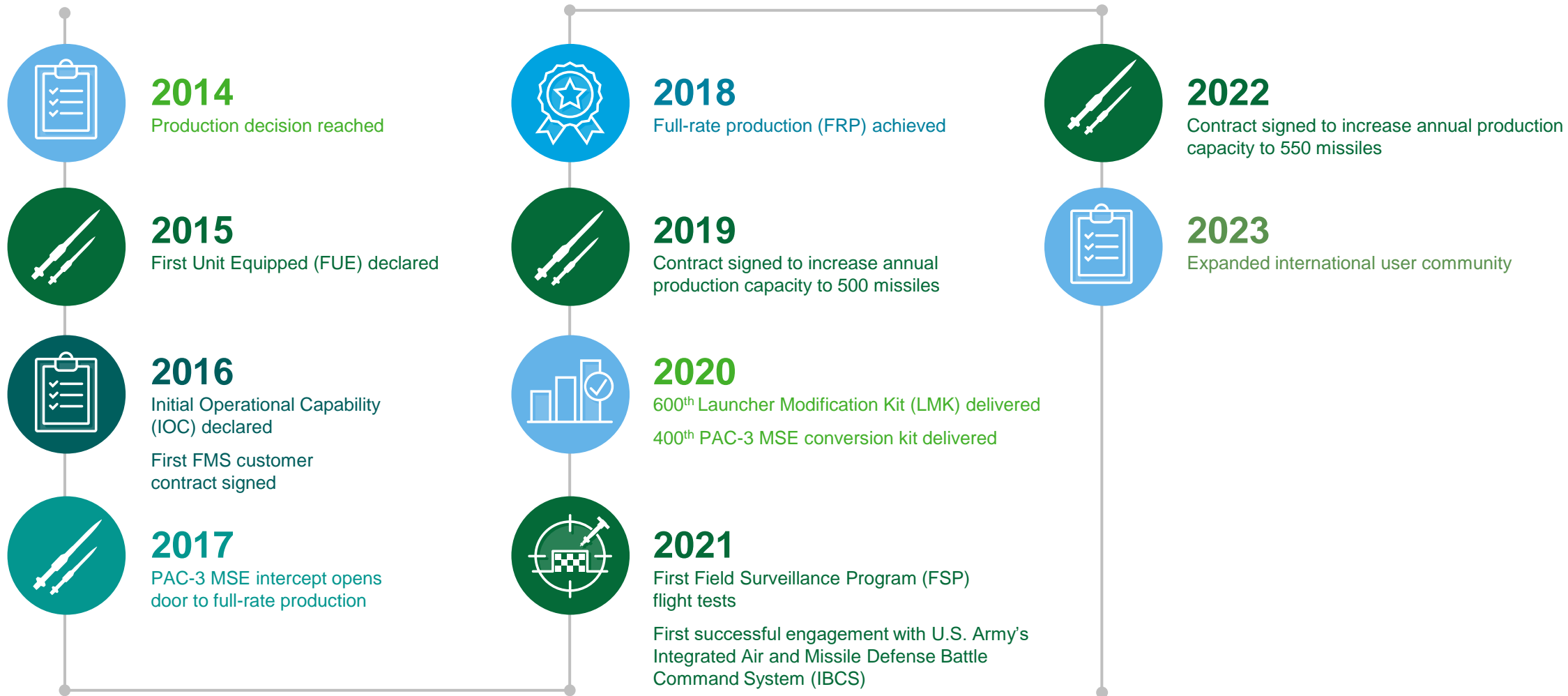

PAC-3 International User Community

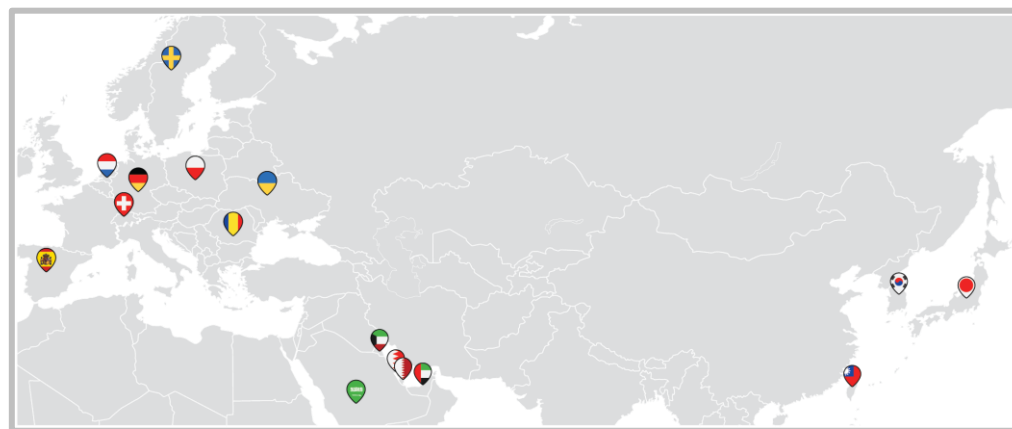
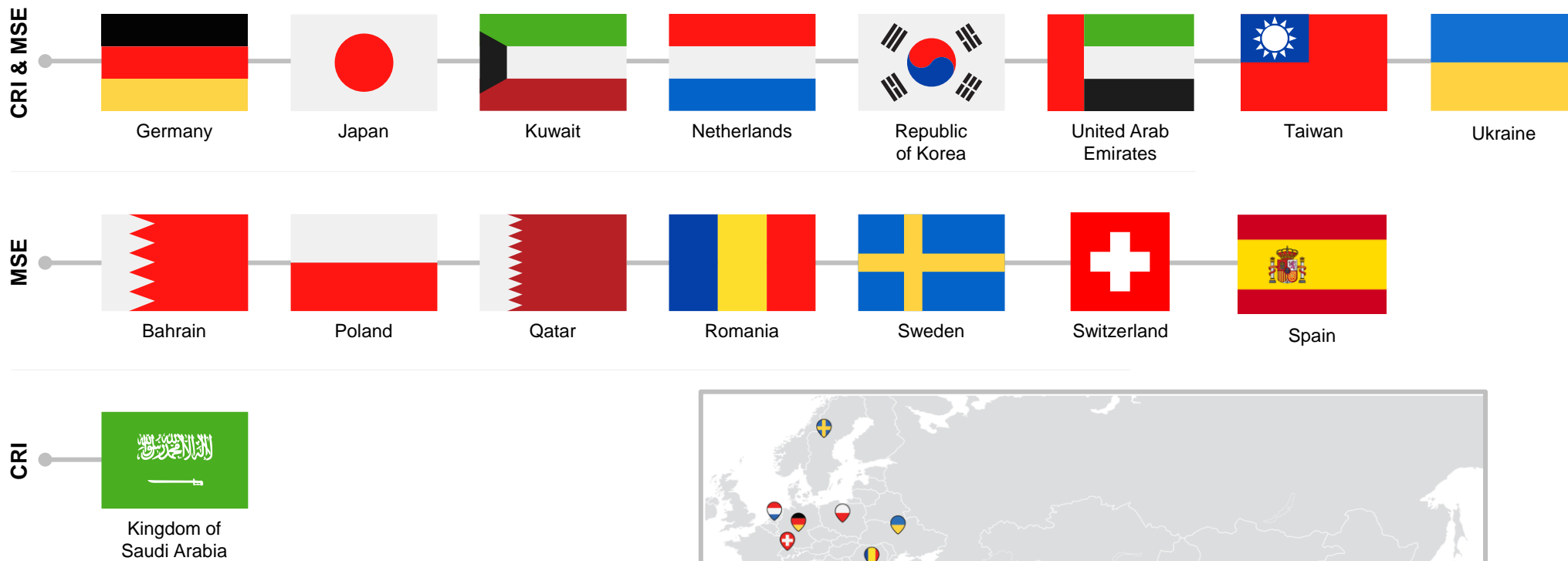

16 INTERNATIONAL PARTNER NATIONS

PAC-3 International User Community

Europe

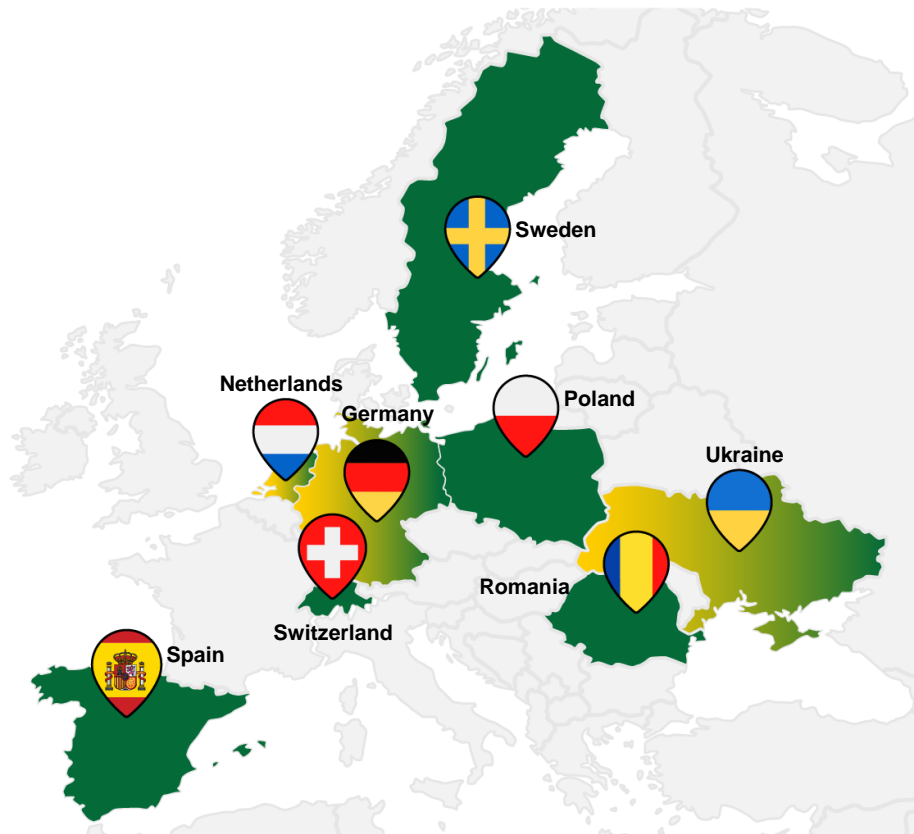

Middle East

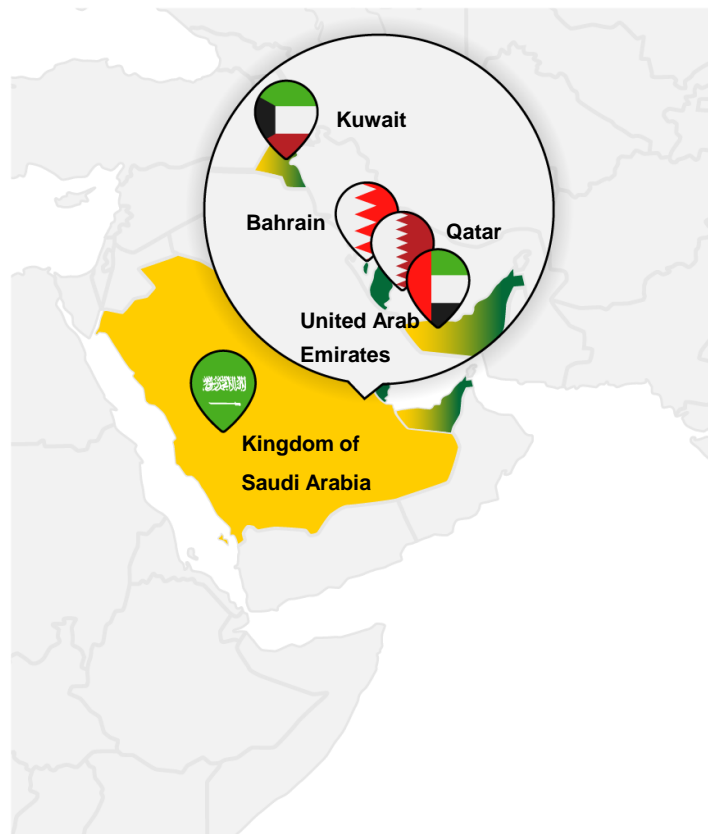

Asia Pacific

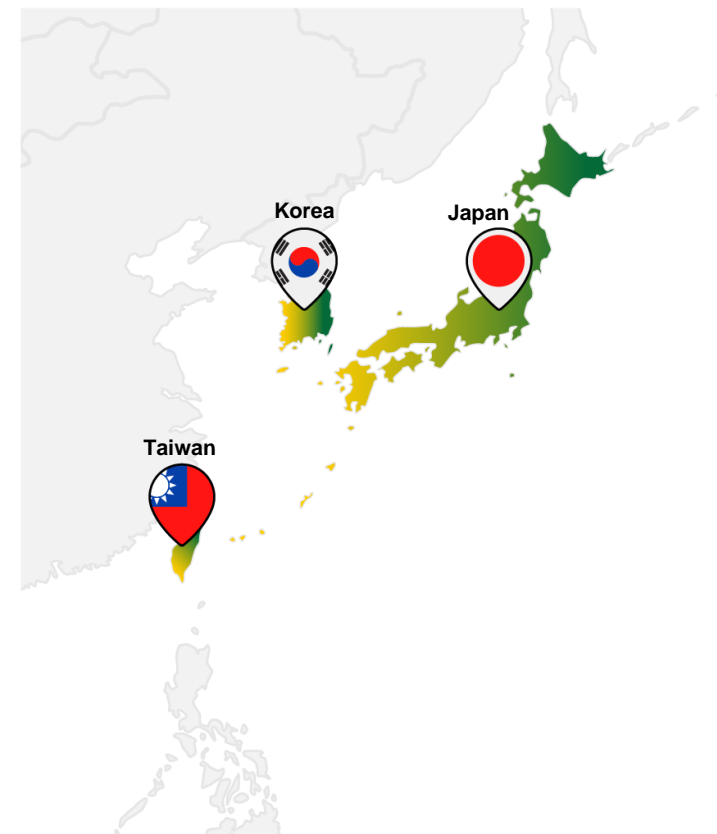

● PAC-3 CRI Partner Nation
 ● PAC-3 MSE Partner Nation

Hit-to-Kill Technology

PAC-3 Hit-to-Kill Fundamentals



Sensing the Threat

- Highly accurate seeker
- High data processing rates
- Scanning and search capability



Guidance

- Optimum engagement geometry
 - Aimpoint selection
- High-speed computing of guidance algorithms
- World-class simulation and testing



Hitting the Threat

- Extremely responsive control system with forward-mounted side thrusters
- High agility airframe



Lethality

- High-energy impact defends against current and emerging threats
 - Momentum transfer

Energy Required for Intercept

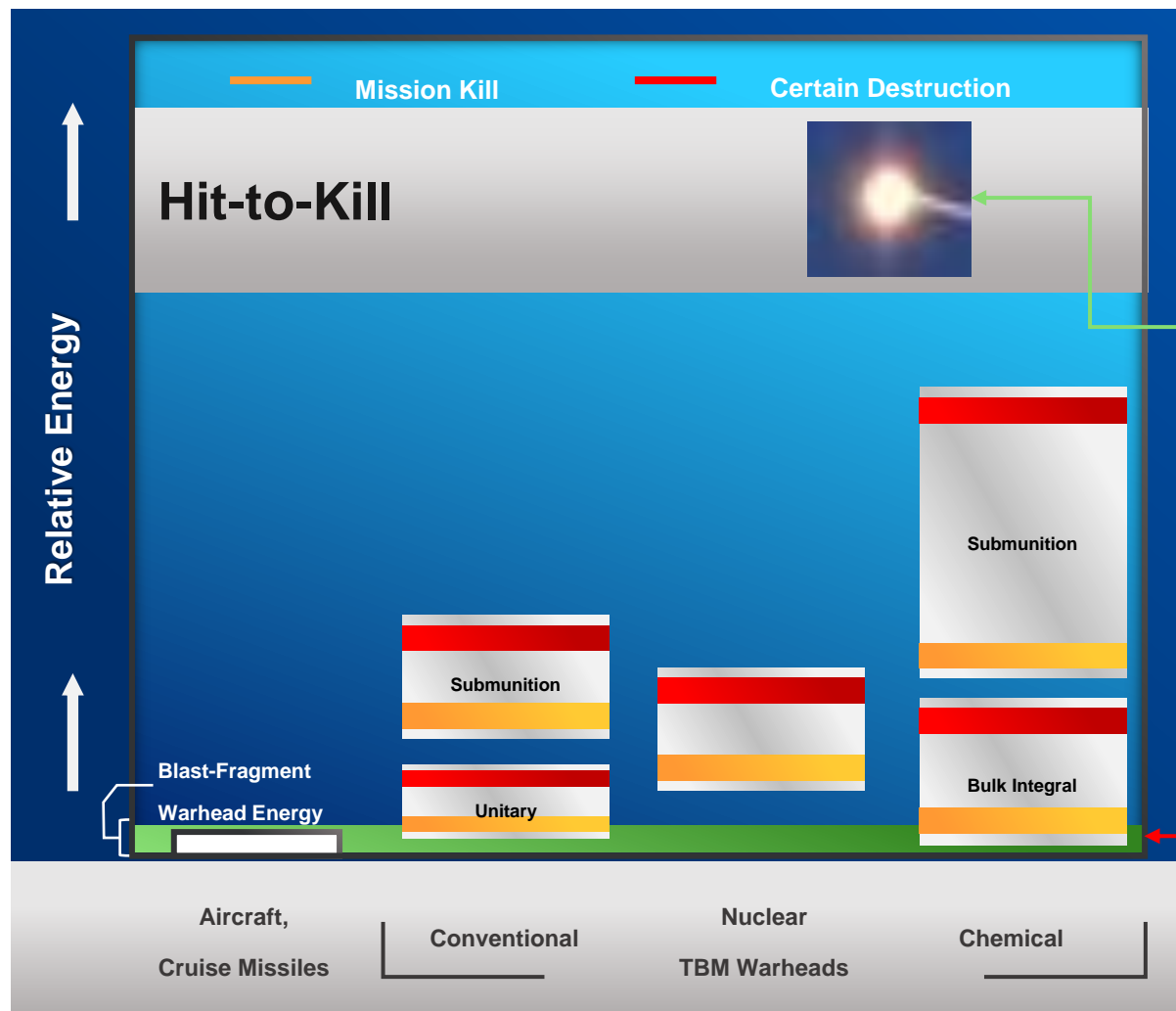

Effectiveness vs. Submunitions

Hit-to-Kill Intercept

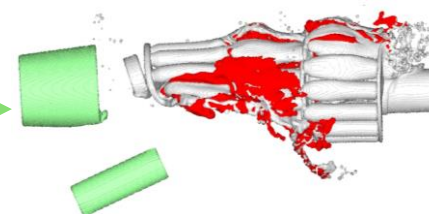

- Typically the aeroshell is destroyed
- Most submunitions are destroyed
- Remaining submunitions typically sustain moderate to significant deformation
- Debris propagates downwards

Blast Frag Intercept

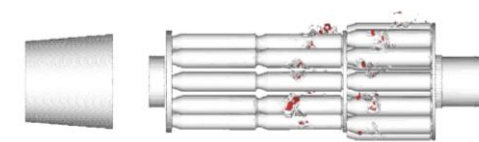

- Typically the aeroshell is destroyed
- Few submunitions are punctured
- Outer layer of submunitions provides effective shielding of inner layer and far-side submunitions
- Ballistic trajectory of debris is generally unchanged

Preventing lethal effects on the ground requires Hit-to-Kill

Hydrocode Analysis of the Intercept

Blast Frag Intercept

Delivers a few mega joules of energy on the target

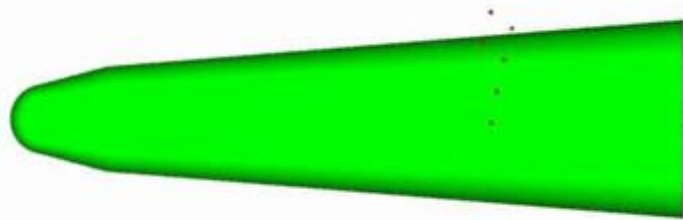

VIDEO - Click on picture

Hit-to-Kill Intercept

Delivers hundreds of mega joules of energy on the target

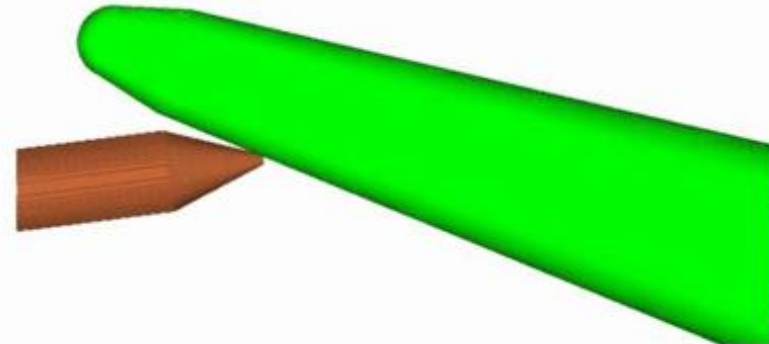

VIDEO - Click on picture

Hydrocode provides a means to analyze the intercept dynamics of missile defense intercept mechanisms

Debris on the Ground

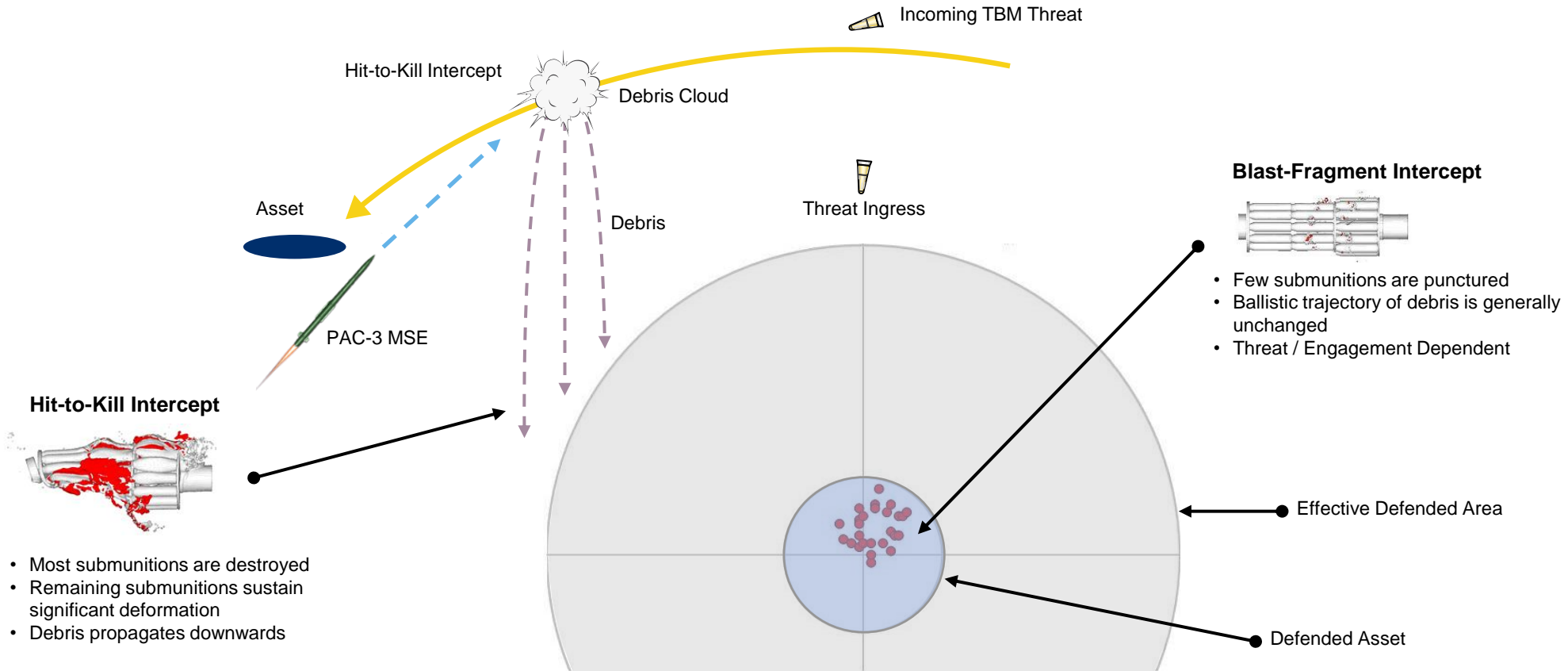

Protect Defended Asset and Minimize Collateral Damage

PAC-3 Missile Segment

How PAC-3 MSE Works

**Patriot Configuration*

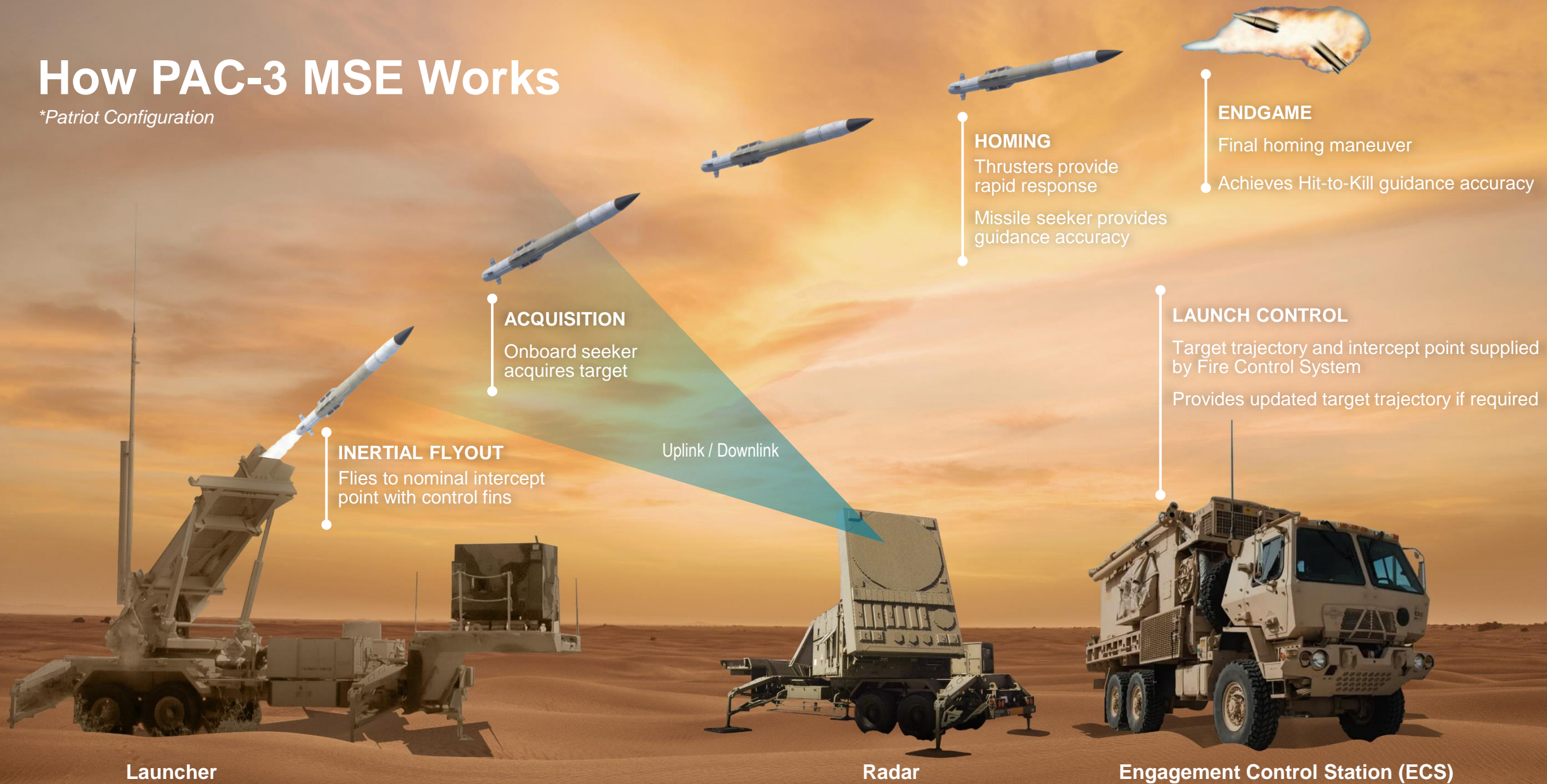

Launcher

Radar

Engagement Control Station (ECS)

INERTIAL FLYOUT
Flies to nominal intercept point with control fins

ACQUISITION
Onboard seeker acquires target

HOMING
Thrusters provide rapid response
Missile seeker provides guidance accuracy

ENDGAME
Final homing maneuver
Achieves Hit-to-Kill guidance accuracy

LAUNCH CONTROL
Target trajectory and intercept point supplied by Fire Control System
Provides updated target trajectory if required

Uplink / Downlink

PAC-3 Missile Segment Components



M903 Launcher Components

1. PAC-3 MSE One-Packs
2. Junction-Box / Launching Station Diagnostic Unit (J-Box/LSDU)
 - Power/signal distribution for missile umbilicals
 - Performs cable diagnostic test
3. Launcher Cables
 - ELES/J-Box/LSDU interconnect
 - Dedicated umbilicals for PAC-3
4. Enhanced Launcher Electronics System (ELES)
 - Provides power and signals to missiles



Canister

PAC-3 MSE One-Pack facilitates launcher reconstitution

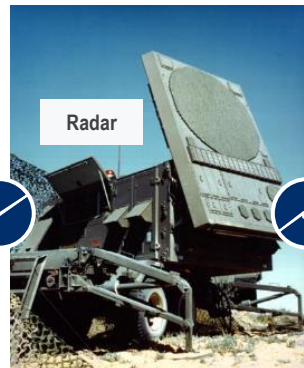

Fire Solution Computer Redesign (FSCR)

Calculates PAC-3 missile engagement solutions

PAC-3 Hit-to-Kill Missiles



PAC-3 MSE Interceptor

- Small (diameter, length, weight)
- Rapid acceleration from solid rocket motor (SRM) boost phase
- Sustain phase maintains high velocity for Hit-to-Kill engagement with second pulse for long-range or high-altitude intercepts
- Dual-control autopilot provides fast divert response
 - Aerodynamic Maneuvering System (control fins)
 - Attitude Control Section - Attitude Control Motors (ACM)
- High-power, highly accurate, all-weather active Ka band radar seeker
 - Range, range rate, angle data to homing guidance
- Guidance Processor Unit (GPU) - Main computer
- Inertial Measurement Unit (IMU) - Navigation system
- Multi-band Radio Frequency Data Link (MRFDL) – Uplink/downlink communication

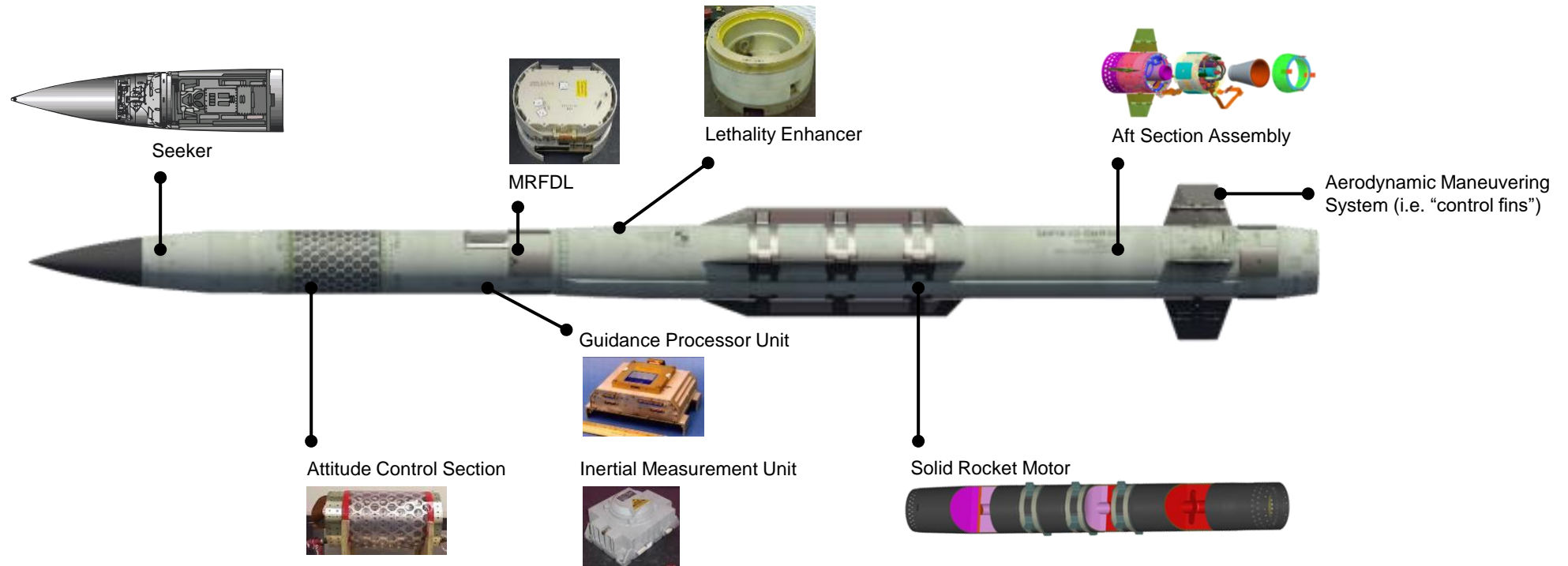

PAC-3 MSE Capability Enhancements

- Provides performance growth against existing and advanced threats
- Improves lethality and maneuverability over entire battlespace
- Increases footprint significantly against threats
- Provides improved Insensitive Munitions (IM) capability
- One-Pack approach improves operational flexibility
- Achieves larger battlespace with longer range and higher altitude

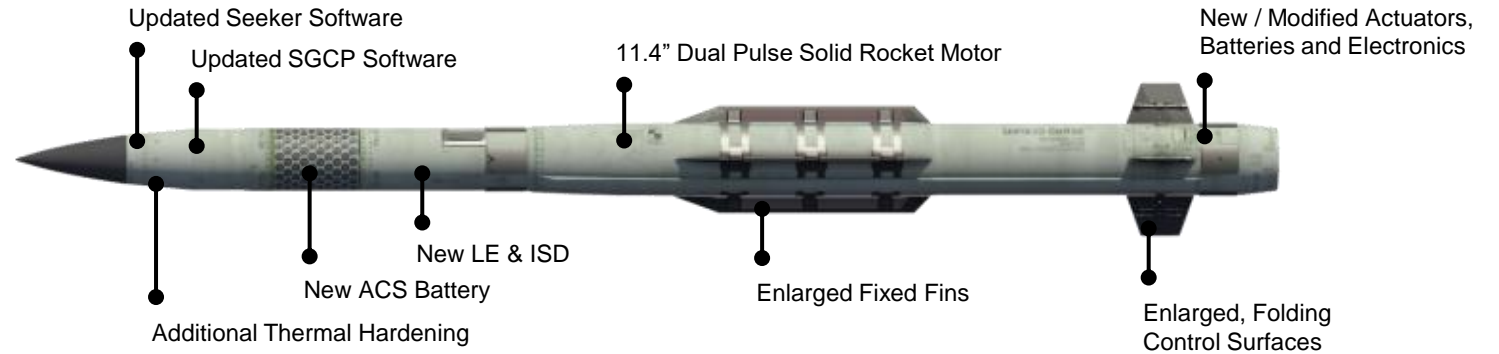

Significant battlespace growth

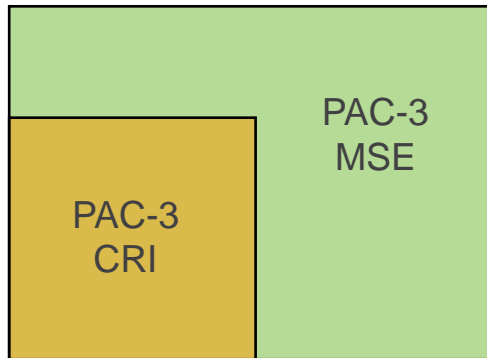

Jointly defined ECS changes with Raytheon

Updated FSCR software



- "Kitted" Single Canister
- Armor
- TIVS
- Updated ELES software

PAC-3 MSE defends against new and evolving threats while increasing capability against existing threats

PAC-3 MSE Canister Design Overview

One-Pack, External Components

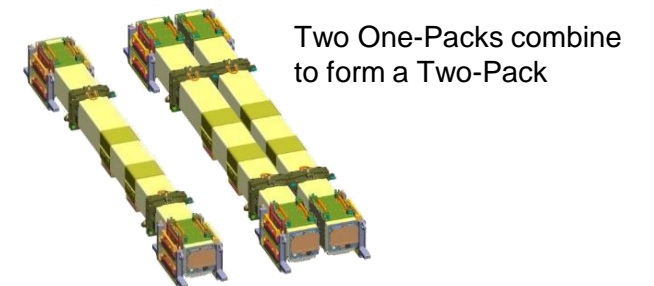
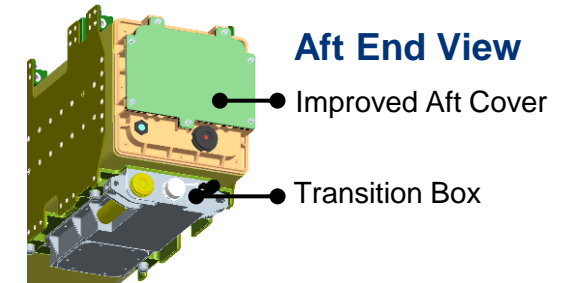
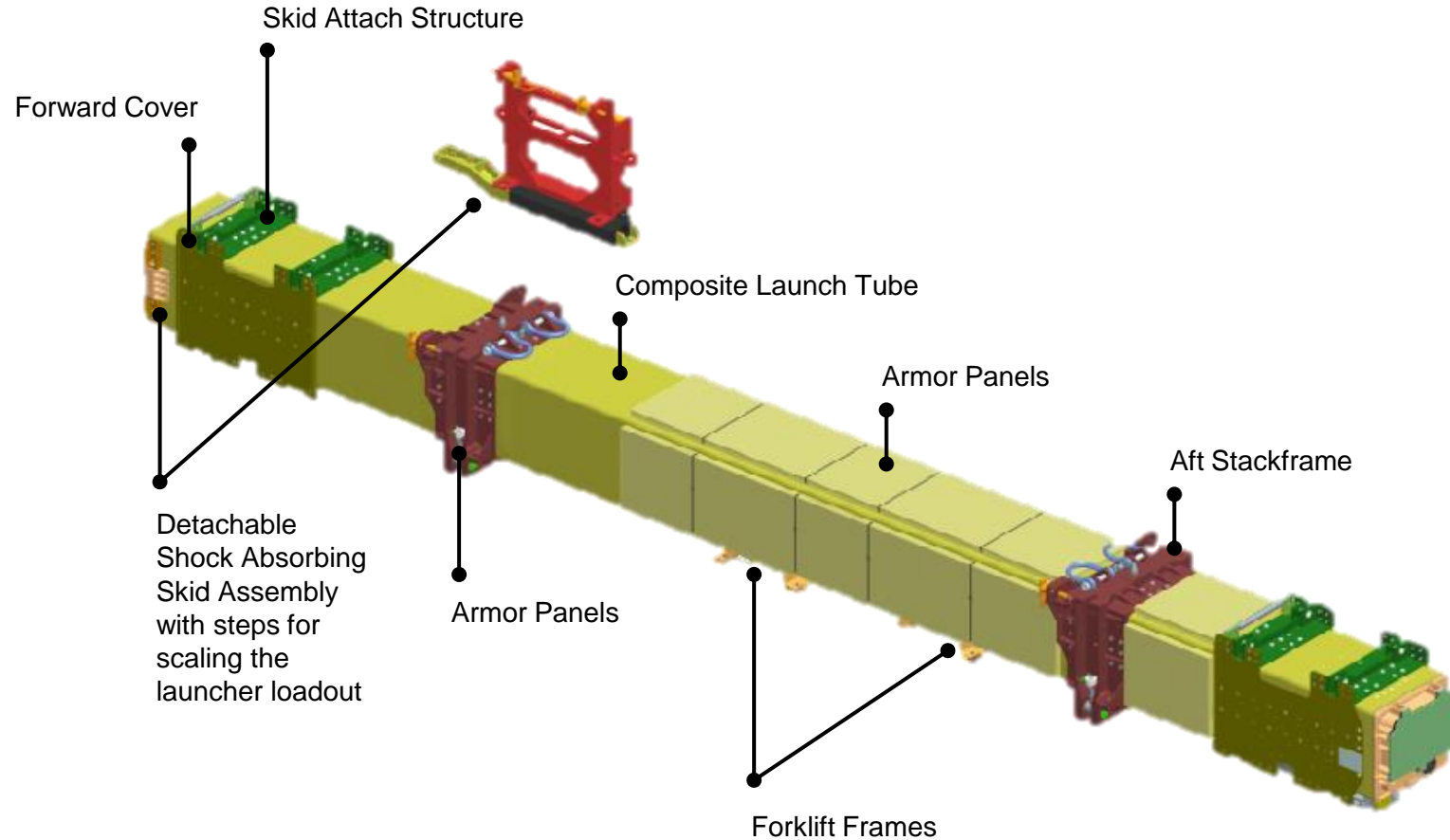

MSE Single Canister Summary

Reconstitution / Reload	One-Packs are field replaceable. Single use canister, missiles are not reconstitutable.
Explosive Ordnance Disposal (EOD) of Single Missile	Single One-Pack may be removed and disposed.
Shipping Configurations	Can ship as double Two-Pack, Two-Pack, or One-Pack.
OCONUS Road March	12 missile max load meets OCONUS height requirements without need for off-loading.
Insensitive Munitions Compliance	System is IM compliant.
Modularity	Mechanical interfaces maintained for multiple launcher platforms.

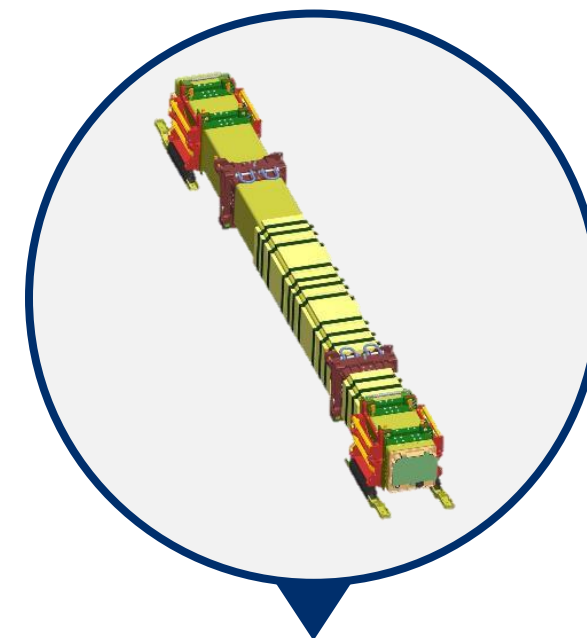

Launcher Upgrades

PATRIOT Load Out Options

- PAC-3 provides up to four times the firepower and less reloads versus PAC-2 family of missiles.
- PAC-3 CRI and PAC-3 MSE provide high load out configurations and enable defense against mass raids.

- M903 allows for a mix of PAC-3 CRI and PAC-3 MSE missiles.
- All new US launchers are M903 configuration.

M903 can launch entire family of Patriot missiles



M901

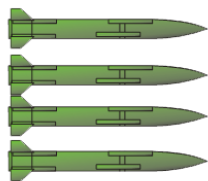

4 PAC-2 (GEM)



M902

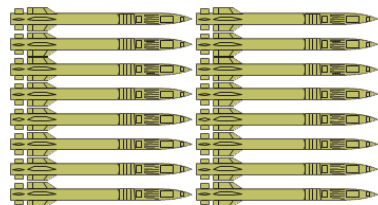

16 PAC-3 CRI
or 4 PAC-2 (GEM)



M903



12 PAC-3 MSE, or 16 PAC-3 CRI
or 4 PAC-2 (GEM)

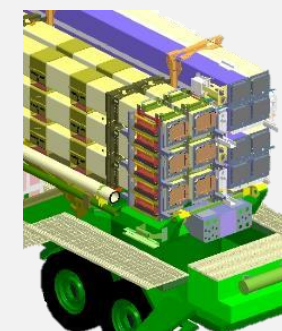

M903

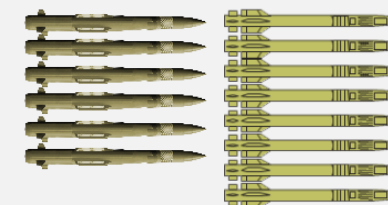

6 PAC-3 MSE and 8 CRI
or 4 PAC-2 (GEM)

Summary

Summary

- The PAC-3 family of missiles are **combat proven Hit-to-Kill interceptors** that defend against incoming threats, including tactical ballistic missiles, cruise missiles, advanced threats, and aircraft.
- PAC-3 missiles defend against incoming threats through direct body-to-body contact **delivering exponentially more kinetic energy on the target** than can be achieved with blast-fragmentation kill mechanisms.
- Building on the combat-proven PAC-3 CRI, the PAC-3 MSE **expands the lethal battlespace** with a two-pulse solid rocket motor, providing increased performance in altitude and range.
- **Fifteen** nations have chosen PAC-3 to provide missile defense capabilities.



World's Most Advanced
Air Defense Missile



Acronyms

ABT	Air Breathing Threat	GSE	Ground Support Equipment	PALS	PATRIOT Automated Logistics System
ACM	Attitude Control Motors	GTF	Guided Test Flight	POP	Proof of Principle
ACS	Attitude Control System	HTK	Hit-to-Kill	REP	Radar Enhancement Phase
AMS	Aerodynamic Maneuvering System	HW	Hardware	RDP	Radar Digital Processor
ARM	Anti-Radiation Missile	IM	Insensitive Munitions	RF	Radio Frequency
CDI	Classification, Discrimination, Identification	IMU	Inertial Measurement Unit	RLCEU	Remote Launch Communications Enhancement Upgrade
Config	Configuration	IOC	Initial Operational Capability	RPV	Remotely Palletized Vehicle
CONUS	Continental United States	ISD	Ignition Safety Device	SBC	Single Board Computer
COTS	Commercial off-the-shelf	J-Box	Junction Box	SGCP	System Guidance Computer Program
CRI	Cost Reduction Initiative	Km	Kilometer	SIG	Signal
D-Cables	Distribution Cables	LE	Lethality Enhancer	SP	Shorting Plug
D-Box	Distribution Box	LEM	Launcher Electronics Module	SRHIT	Small Radar Homing Interceptor Technology
DT	Development Test	LMRD	Launcher Missile Round Distributor	SRM	Solid Rocket Motor
ECS	Engagement Control Station	LS	Launching Station	SW	Software
ELES	Enhanced Launcher Electronics System	LMK	Launcher Modification Kit	TBM	Tactical Ballistic Missile
EOD	Explosive Ordnance Disposal	LSDU	Launcher Station Diagnostic Unit	T-Box	Transition Box
ERINT	Extended Range Interceptor	MAP	Modular Adjunct Processor	THAAD	Terminal High Altitude Area Defense
EWCC	Expanded Weapons Control Computer	MEADS	Medium Extended Air Defense System	TIVS	Thermally Initiated Venting System
FLAGE	Flexible Lightweight Agile Guided Experiment	MFG	Master Frequency Generator	UMB	Umbilical Cable
FMS	Foreign Military Sales	MRFDL	Multi-band Radio Frequency Downlink	UL	Upper Left
FOTP	Follow-on Test Program	MSE	Missile Segment Enhancement	UR	Upper Right
FSC	Fire Solution Computer	MSL	Missile	VME	Versa Module Eurocard
FSCR	Fire Solution Computer Redesign	NFS	North Finding System	WMD	Weapon of Mass Destruction
FUE	First Unit Equipped	OCONUS	Outside the Continental United States		
FWD	Forward	OT	Operational Test		
GEM	Guidance Enhancement Missile	PAC-3 @	Patriot Advanced Capability-3		
GMT	Guided Missile Transporter	PDB	Post Deployment Build		
GPU	Guidance Processor Unit				